

P/N: FAPE302352

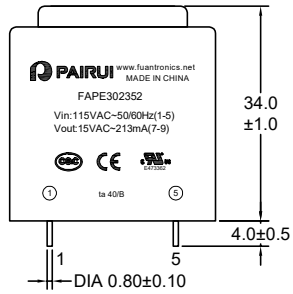

Outline Dimensions(Unit:mm)



Front View



Side View

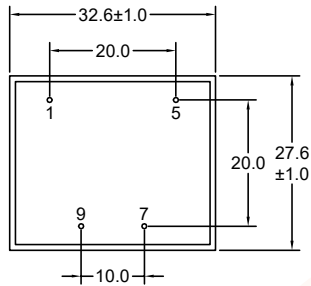

Bottom View

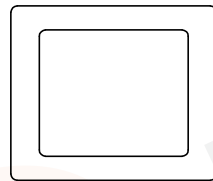

Top View

Note:

- 1.Remove Pins 2,3,4,6,8,10.

Wave Soldering

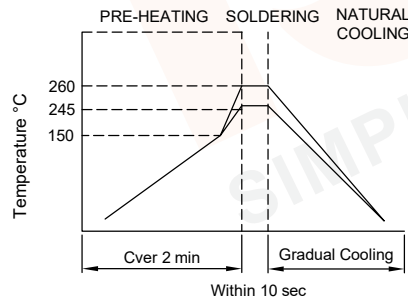

- Note:
- 1.Never Contact the ceramic with the iron tip;
 - 2.1.0mm tip diameter(max).

Electronical Schematic

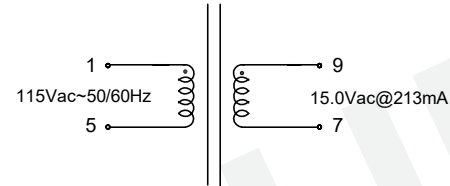

Electrical Characteristics

Input 115Vac 60Hz to 1-5 :
Excitation current(Ix):15.0mA Max.
Output: Vo=24.0Vac Typ(No-load).
VL=15.0Vac±5%(@213mA).
Hi-Pot: Pri-Sec:4000VAC/5mA/60Second.

General Properties

Operating Temperature:-25°C to +40°C.
Storage Temperature:-25°C to +85°C.
Insulation Class: B.

| | | | | | | | | |
|-----|-------------|------|------|---|---|---|---|--|
| REV | DESCRIPTION | APPD | DATE | Tianchang Fuan Electronic Co Ltd www.fuantronics.net TEL: +86-550-7814888 FAX: +86-550-7831133 | <p>Tolerances unless otherwise specified: (.X)±0.50 (XX)±0.25 Unit of measurement: mm</p> | Make: Qiumei.Liu Checked: Beson. zhan Approved: Anson. zhan | DRAWING TITLE 3.20W Encapsulated Transformer For E130*23,115VAC Input 50/60Hz Material Number: A223023XS510 | Customer Name: Document/Rev: 00 Specification Sheet: 1 of 3 Date of Recognition: Jan./02/2020 |
| | | | | | | | | |
| | | | | | | | | |

P/N: FAPE302352



List of UL Certificate:

| No. | Part Name | Mat'l Description | Supplier | UL Number |
|-----|-------------|---------------------------|-------------------------------------|-----------|
| 1 | Bobbin | EI30*23/PBT(Black) | Chang Chun Plastics Co Ltd | E59481 |
| 2 | Case | CASE-EI30*23/PA66(Orange) | Zhejiang Juner New Materials Co Ltd | E204321 |
| 3 | Copper wire | 2UEW-F/155C | Elektrisola Hangzhou Co Ltd | E258243 |
| 4 | Core | Lamination | Ta Yea Steel Industry Co Ltd | N/A |
| 5 | Epoxy | PU552(Black) | Wevo-Chemle Gmbh | E108835 |
| 6 | | | | |

Packaging Specification:

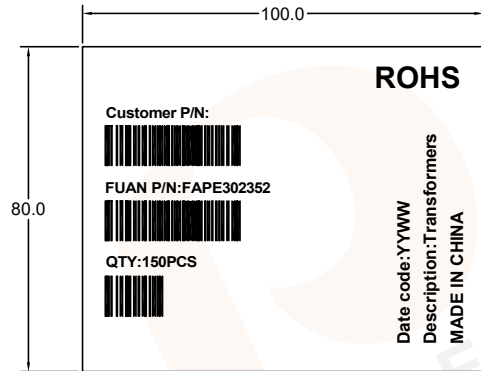

Laber of outer

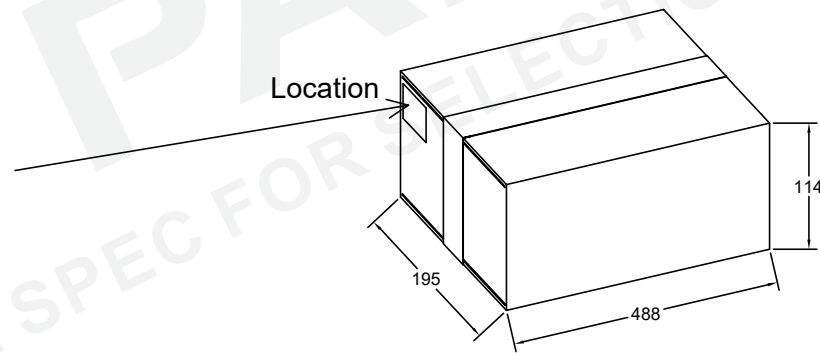

put the label on the top left corner of one of the carton sides

| | | | | | | | | |
|-----|-------------|------|------|---|--|---|---|--|
| | | | | Tianchang Fuan Electronic Co Ltd www.fuantronics.net TEL: +86-550-7814888 FAX: +86-550-7831133 | Tolerances unless otherwise specified: (.X)±0.50 (XX)±0.25 Unit of measurement: mm | Make: Qiumei.Liu Checked: Beson. zhan Approved: Anson. zhan | DRAWING TITLE 3.20W Encapsulated Transformer For EI30*23,115VAC Input 50/60Hz Material Number: A223023XS510 | Customer Name: Document/Rev: 00 Specification Sheet: 2 of 3 Date of Recognition: Jan./02/2020 |
| REV | DESCRIPTION | APPD | DATE | | | | | |

P/N: FAPE302352

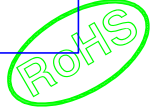

Packing Method:

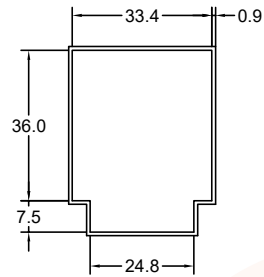
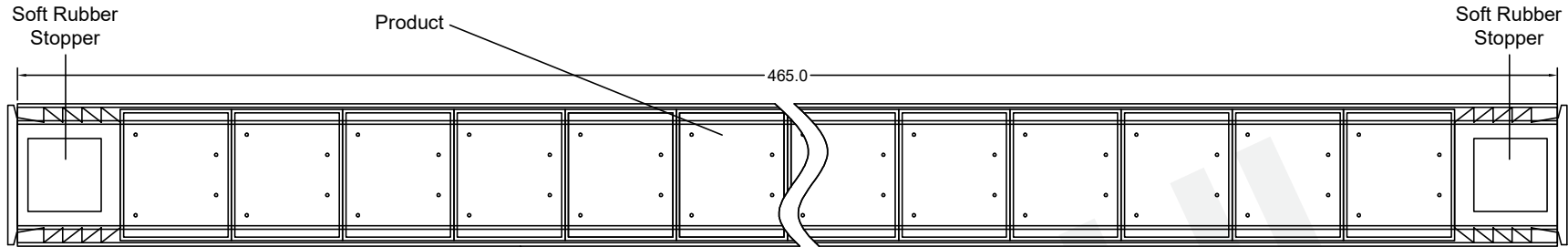

Size of packaging tube:
465mm*35.2mm*45.3mm
(Length * Width * Height)

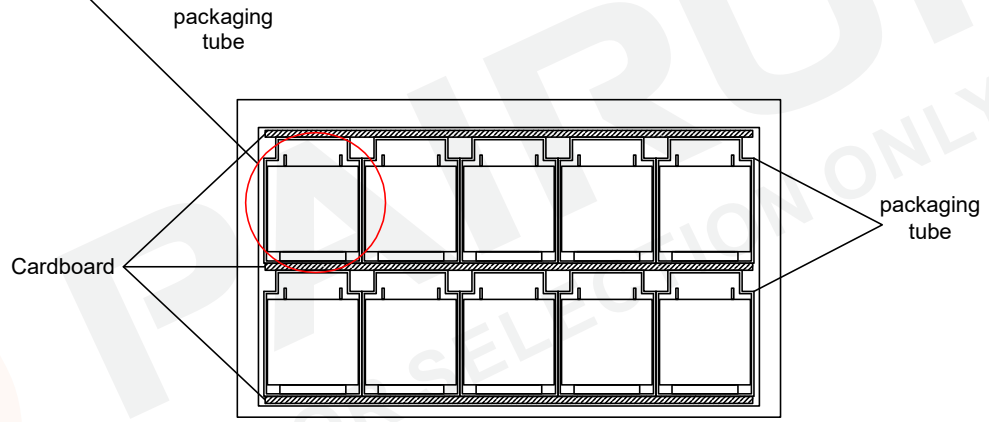

Carton Box Side View

| Layer/Carton | Quantity/Tube (pcs) | Quantity/Carton (pcs) | Net weight (g/pc) | Gross weight (g/tube) | Tubes/carton (pcs) | Total weight (kg) | box size Dimensions (mm) |
|--------------|---------------------|-----------------------|-------------------|-----------------------|--------------------|-------------------|--------------------------|
| 2.0 | 15.0 | 150.0 | 135.0 | 118.20 | 10.00 | 22.00 | 488*195*114 |

| REV | DESCRIPTION | APPD | DATE |
|-----|-------------|------|------|
| | | | |

Tianchang Fuan Electronic Co Ltd
www.fuantronics.net
TEL: +86-550-7814888
FAX: +86-550-7831133



Tolerances unless otherwise specified:
(.X)±0.50 (XX)±0.25
Unit of measurement: mm

Make: Qiumei.Liu
Checked: Beson. zhan
Approved: Anson. zhan

DRAWING TITLE
3.20W Encapsulated Transformer
For EI30*23,115VAC Input 50/60Hz
Material Number: A223023XS510

Customer Name:
Document/Rev: 00
Specification Sheet: 3 of 3
Date of Recognition: Jan./02/2020